

MOLIVA3D C3
CUSTOM CLIMATE CONTROL

M3D

CUSTOM CLIMATE CONTROL

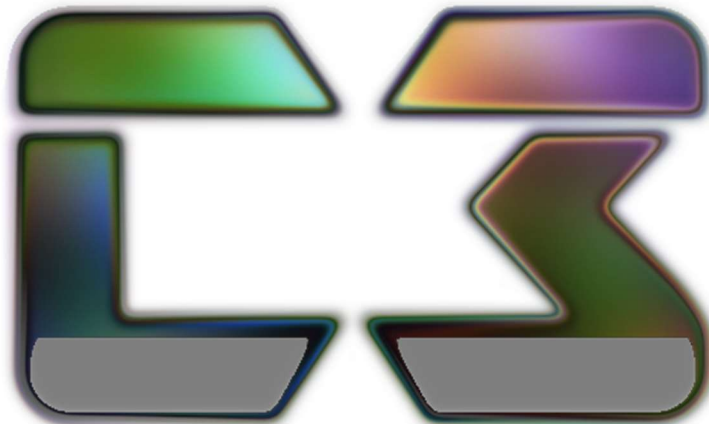

MOLIVA LLC

CONNECTING THE MOLIVA3D C3

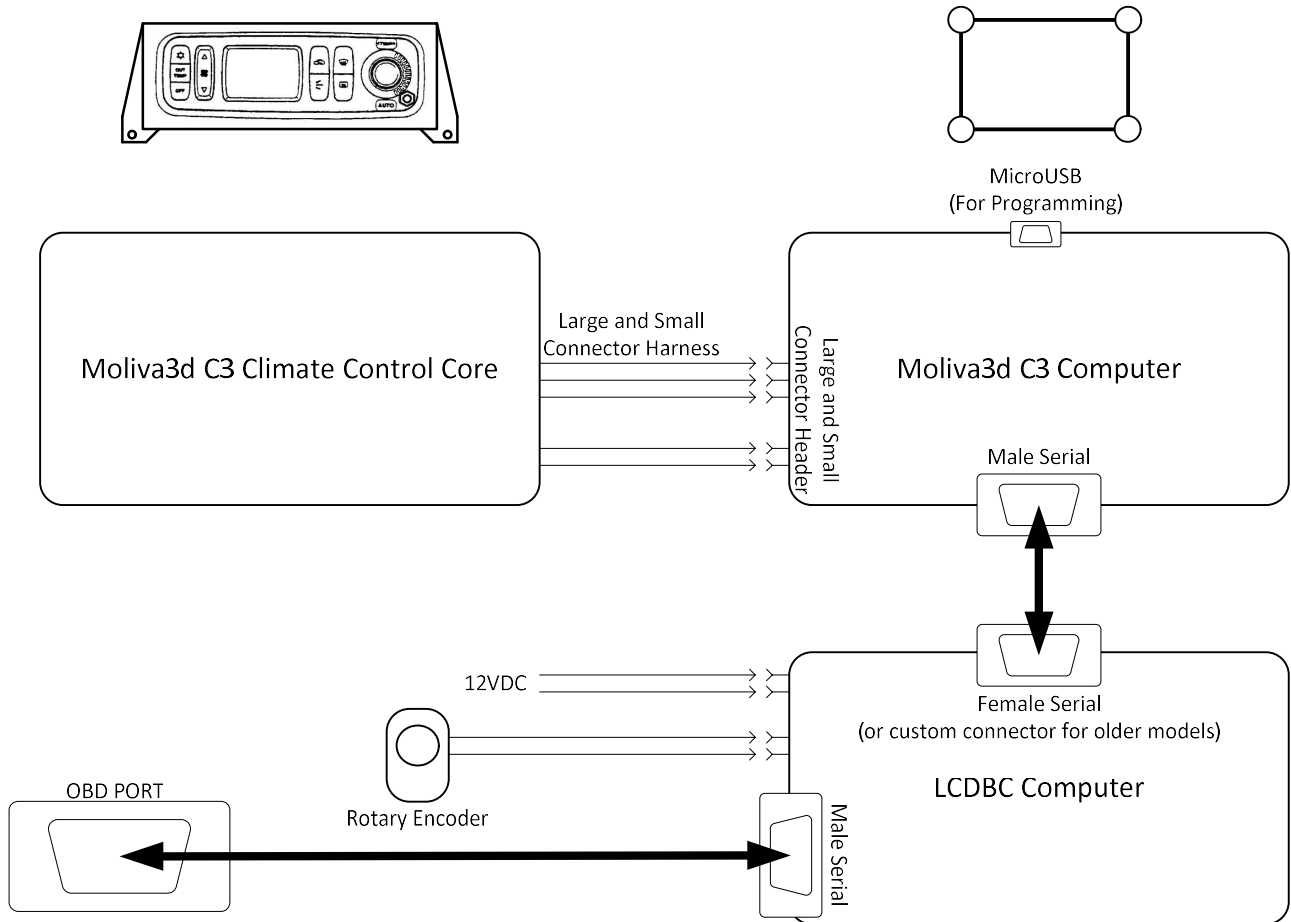

MOLIVA3D C3 DISPLAY INTERFACE

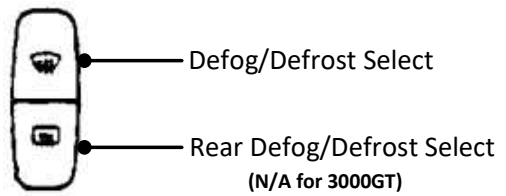
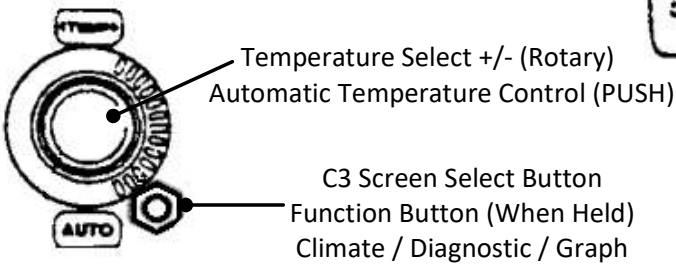
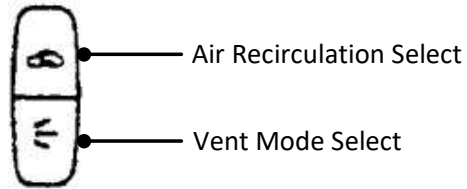
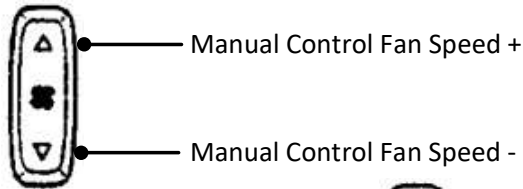
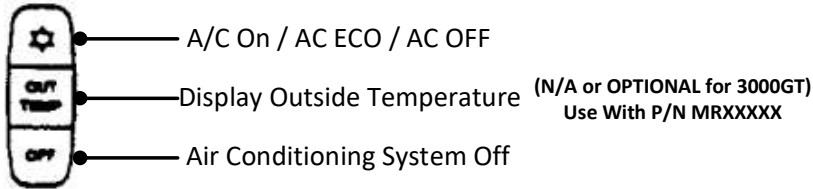
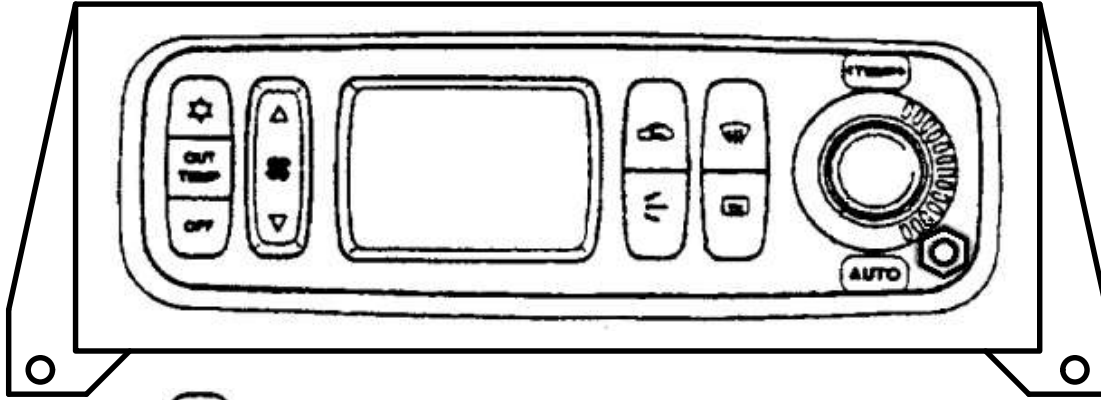

MOLIVA3D C3 CLIMATE SCREEN

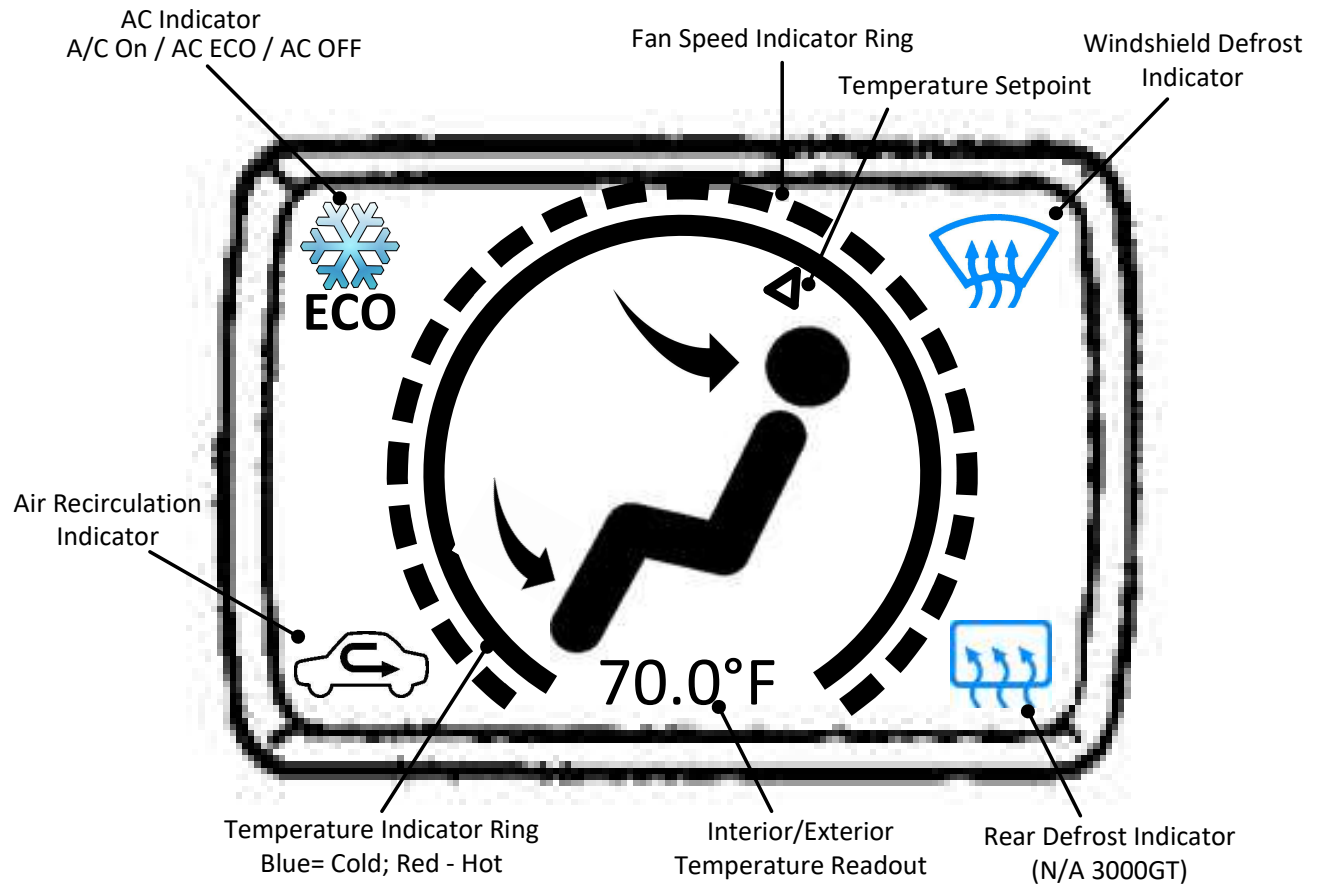

MOLIVA3D C3 DIAGNOSTIC SCREEN

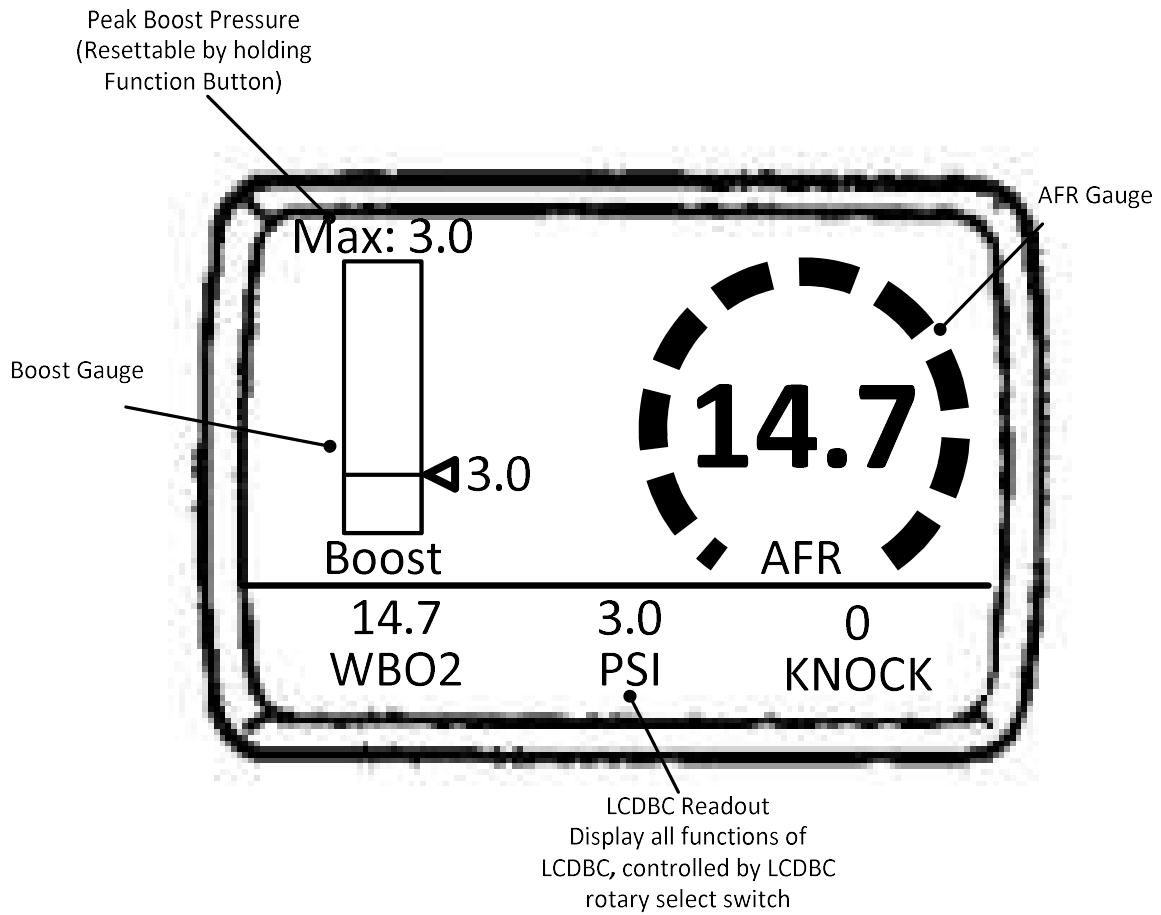

MOLIVA3D C3 PLOT SCREEN

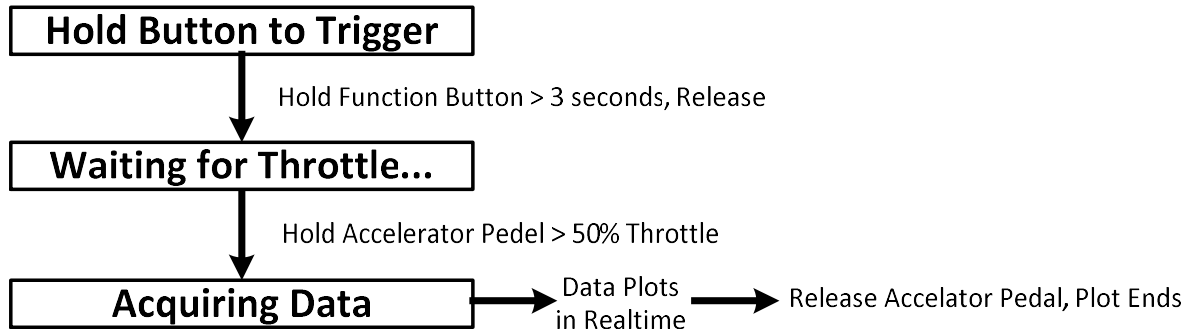
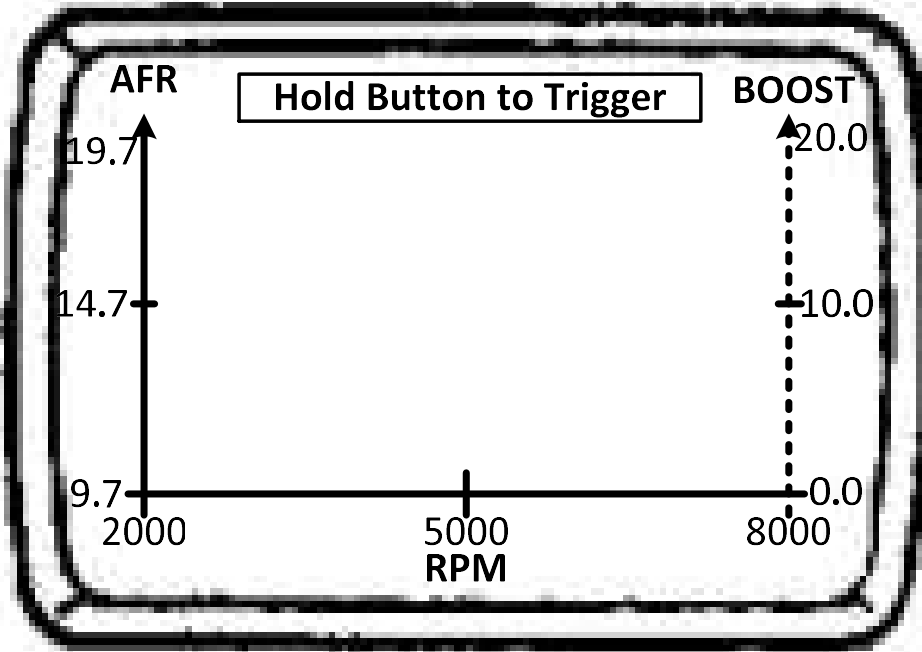

DISCLAIMER

Increased turbo boost pressure could harm your engine and/or turbocharger, the customer assumes full responsibility for any damages that may occur